

GT-F0507 S R 20 -XX X XX 01

G-Switch

Series No

Termipoint  
S-SMT

Angle  
R-90°

Terminal Plating  
01-G/F

Housing Colour  
S-Nature

Pin Q' PY  
05~80

Height  
20-1.95mm

**G-Switch Specification:**

1. Current rated: 0.5A AC/DC
2. Voltage rating: 50V AC/DC
3. Withstanding voltage: 150V AC
4. Contact resistance: 50mΩ max.
5. Insulation resistance: 500MΩ min
6. Durability cycle: 20Cycles
7. Removal force: 0.03kgf/Pin min
8. Operating temperature range: -25°C ~ +85°C

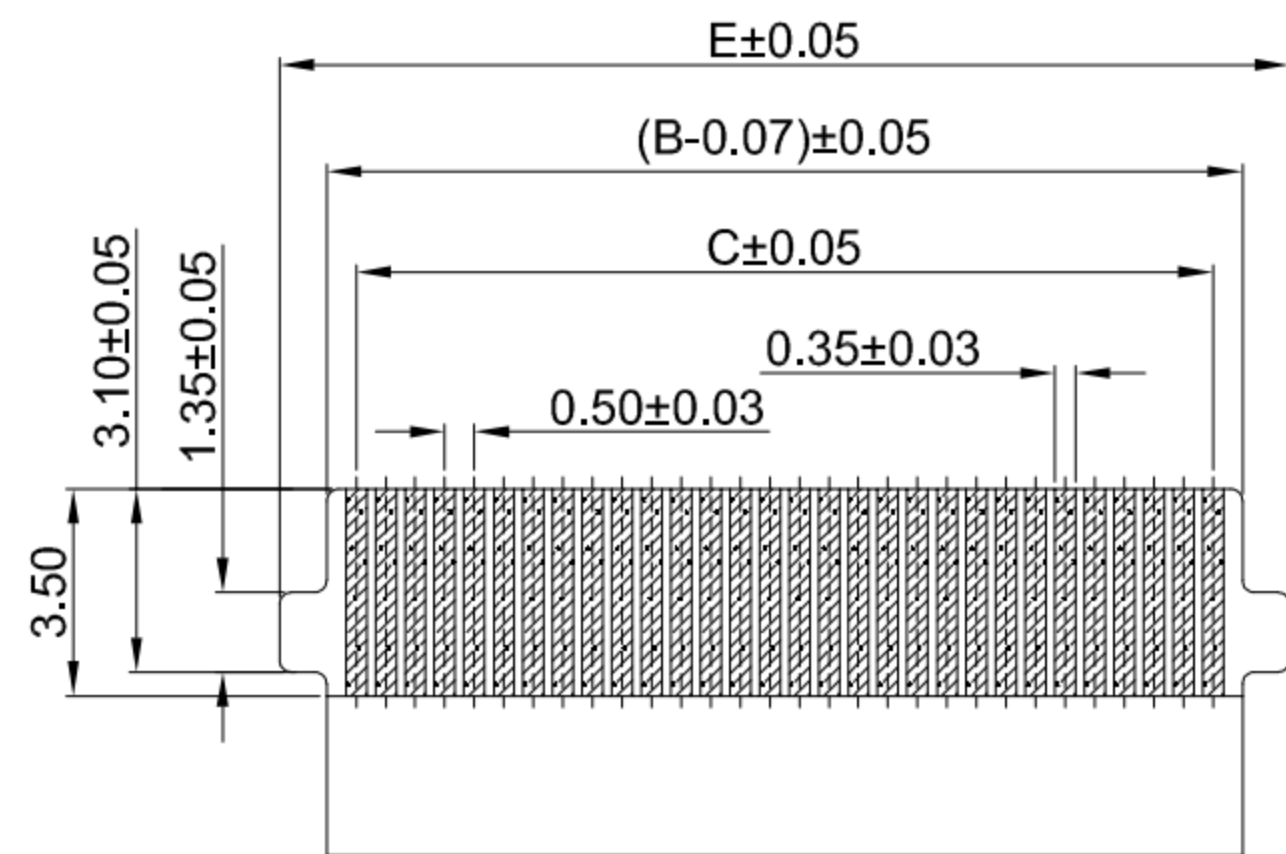
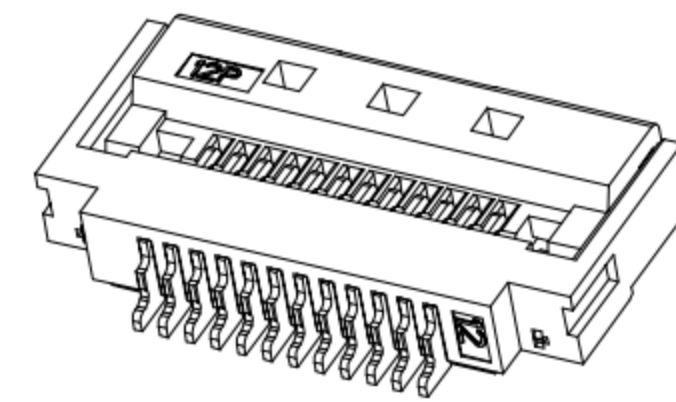
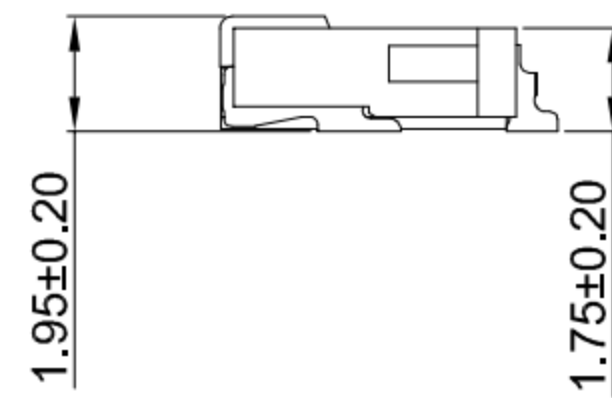
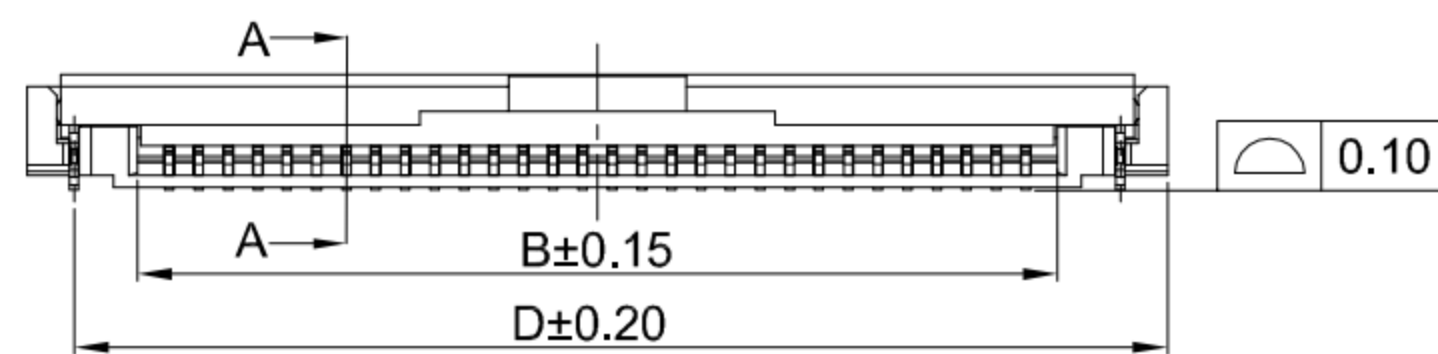

APPLICABLE FPC

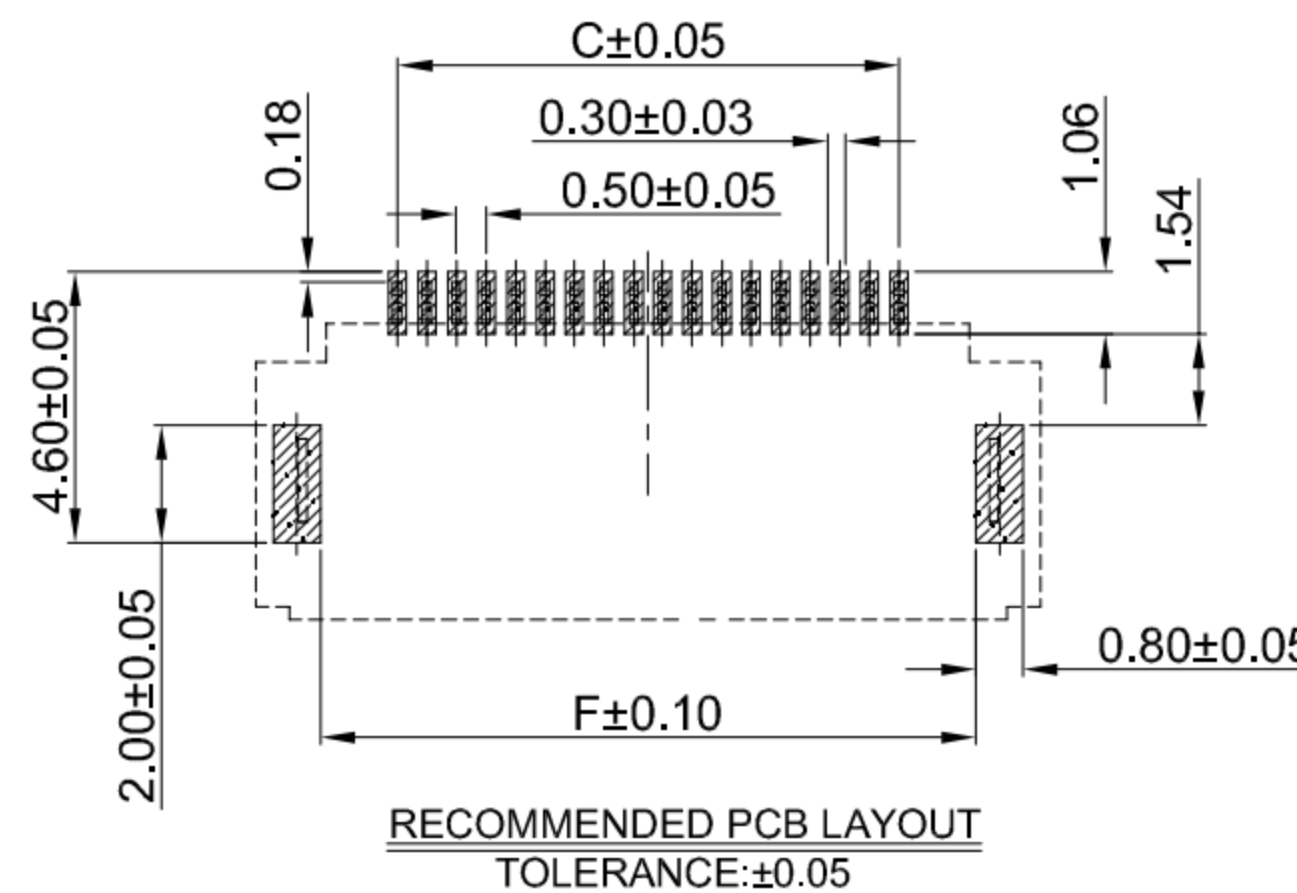
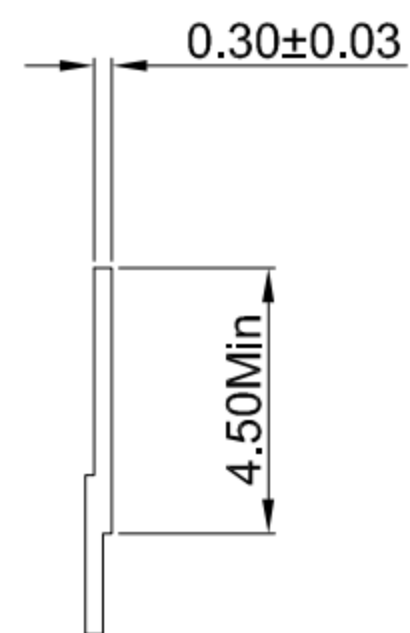

RECOMMENDED PCB LAYOUT  
TOLERANCE: ±0.05

4	SOLDER TABS	PHOSPHOR BRONZE	MATTE Tin
3	CONTACT	PHOSPHOR BRONZE	Gold-Flash On Contact Area
2	COVER	LCP,94V-0	BLACK
1	HOUSING	LCP,94V-0	NATURE
NO.	PART NAME	MATERIAL	REMARK



SCALE: 1:1 UNIT: mm  
SIZE: A4

Unless otherwise  
General Tolerance:  
X ±0.40  
X.x ±0.30  
X.xx ±0.20  
X\* ±5°  
X.x° ±3°

Title: FPC 0.50mm Pitch 90° H2.00mm SMT  
With Lock Connector

Molde Code: GT-F0507SR20-XXXXX01

DRAWN	CHECKED	APPROVED	DATE
Jiang	Hu	Chen	2021.06.28



REV: A0 SHEET: 1/2

**Ordering Information:**

Circuit	Dimensions(mm)						Circuit	Dimensions(mm)					
	A	B	C	D	E	F		A	B	C	D	E	F
05	6.80	3.07	2.00	5.20	4.60	4.60	43	25.80	22.07	21.00	24.20	23.60	23.60
06	7.30	3.57	2.50	5.70	5.10	5.10	44	26.30	22.57	21.50	24.70	24.10	24.10
07	7.80	4.07	3.00	6.20	5.60	5.60	45	26.80	23.07	22.00	25.20	24.60	24.60
08	8.30	4.57	3.50	6.70	6.10	6.10	46	27.30	23.57	22.50	25.70	25.10	25.10
09	8.80	5.07	4.00	7.20	6.60	6.60	47	27.80	24.07	23.00	26.20	25.60	25.60
10	9.30	5.57	4.50	7.70	7.10	7.10	48	28.30	24.57	23.50	26.70	26.10	26.10
11	9.80	6.07	5.00	8.20	7.60	7.60	49	28.80	25.07	24.00	27.20	26.60	26.60
12	10.30	6.57	5.50	8.70	8.10	8.10	50	29.30	25.57	24.50	27.70	27.10	27.10
13	10.80	7.07	6.00	9.20	8.60	8.60	51	29.80	26.07	25.00	28.20	27.60	27.60
14	11.30	7.57	6.50	9.70	9.10	9.10	52	30.30	26.57	25.50	28.70	28.10	28.10
15	11.80	8.07	7.00	10.20	9.60	9.60	53	30.80	27.07	26.00	29.20	28.60	28.60
16	12.30	8.57	7.50	10.70	10.10	10.10	54	31.30	27.57	26.50	29.70	29.10	29.10
17	12.80	9.07	8.00	11.20	10.60	10.60	55	31.80	28.07	27.00	30.20	29.60	29.60
18	13.30	9.57	8.50	11.70	11.10	11.10	56	32.30	28.57	27.50	30.70	30.10	30.10
19	13.80	10.07	9.00	12.20	11.60	11.60	57	32.80	29.07	28.00	31.20	30.60	30.60
20	14.30	10.57	9.50	12.70	12.10	12.10	58	33.30	29.57	28.50	31.70	31.10	31.10
21	14.80	11.07	10.00	13.20	12.60	12.60	59	33.80	30.07	29.00	32.20	31.60	31.60
22	15.30	11.57	10.50	13.70	13.10	13.10	60	34.30	30.57	29.50	32.70	32.10	32.10
23	15.80	12.07	11.00	14.20	13.60	13.60	61	34.80	31.07	30.00	33.20	32.60	32.60
24	16.30	12.57	11.50	14.70	14.10	14.10	62	35.30	31.57	30.50	33.70	33.10	33.10
25	16.80	13.07	12.00	15.20	14.60	14.60	63	35.80	32.07	31.00	34.20	33.60	33.60
26	17.30	13.57	12.50	15.70	15.10	15.10	64	36.30	32.57	31.50	34.70	34.10	34.10
27	17.80	14.07	13.00	16.20	15.60	15.60	65	36.80	33.07	32.00	35.20	34.60	34.60
28	18.30	14.57	13.50	16.70	16.10	16.10	66	37.30	33.57	32.50	35.70	35.10	35.10
29	18.80	15.07	14.00	17.20	16.60	16.60	67	37.80	34.07	33.00	36.20	35.60	35.60
30	19.30	15.57	14.50	17.70	17.10	17.10	68	38.30	34.57	33.50	36.70	36.10	36.10
31	19.80	16.07	15.00	18.20	17.60	17.60	69	38.80	35.07	34.00	37.20	36.60	36.60
32	20.30	16.57	15.50	18.70	18.10	18.10	70	39.30	35.57	34.50	37.70	37.10	37.10
33	20.80	17.07	16.00	19.20	18.60	18.60	71	39.80	36.07	35.00	38.20	37.60	37.60
34	21.30	17.57	16.50	19.70	19.10	19.10	72	40.30	36.57	35.50	38.70	38.10	38.10
35	21.80	18.07	17.00	20.20	19.60	19.60	73	40.80	37.07	36.00	39.20	38.60	38.60
36	22.30	18.57	17.50	20.70	20.10	20.10	74	41.30	37.57	36.50	39.70	39.10	39.10
37	22.80	19.07	18.00	21.20	20.60	20.60	75	41.80	38.07	37.00	40.20	39.60	39.60
38	23.30	19.57	18.50	21.70	21.10	21.10	76	42.30	38.57	37.50	40.70	40.10	40.10
39	23.80	20.07	19.00	22.20	21.60	21.60	77	42.80	39.07	38.00	41.20	40.60	40.60
40	24.30	20.57	19.50	22.70	22.10	22.10	78	43.30	39.57	38.50	41.70	41.10	41.10
41	24.80	21.07	20.00	23.20	22.60	22.60	79	43.80	40.07	39.00	42.20	41.60	41.60
42	25.30	21.57	20.50	23.70	23.10	23.10	80	44.30	40.57	39.50	42.70	42.10	42.10



**GT-F0507 S R 20 -XX X XX 01**

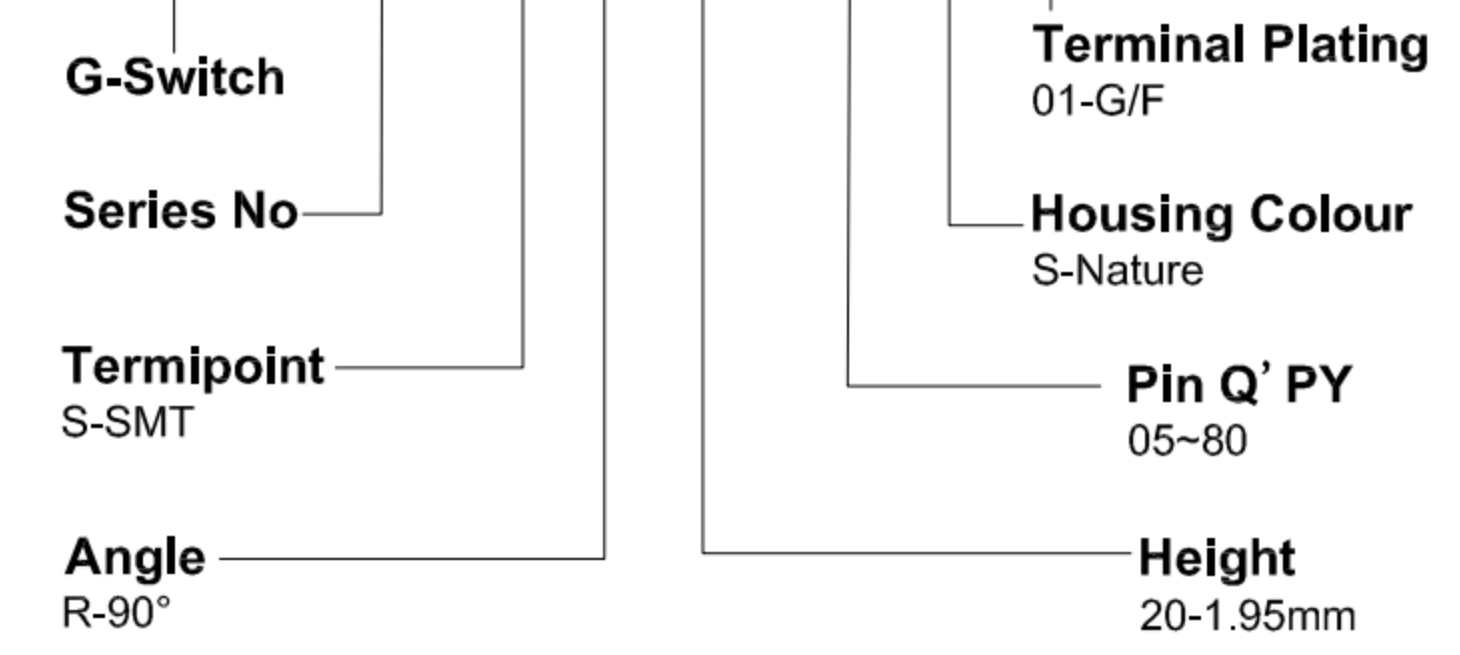

- G-Switch Specification:**
1. Current rated: 0.5A AC/DC
  2. Voltage rating: 50V AC/DC
  3. Withstanding voltage: 150V AC
  4. Contact resistance: 50mΩ max.
  5. Insulation resistance: 500MΩ min
  6. Durability cycle: 20Cycles
  7. Removal force: 0.03kgf/Pin min
  8. Operating temperature range: -25°C ~ +85°C

4	SOLDER TABS	PHOSPHOR BRONZE	MATTE Tin
3	CONTACT	PHOSPHOR BRONZE	Gold-Flash On Contact Area
2	COVER	LCP,94V-0	BLACK
1	HOUSING	LCP,94V-0	NATURE
NO.	PART NAME	MATERIAL	REMARK



SCALE:	1:1	UNIT:	mm
SIZE:	A4		
Unless otherwise General Tolerance:			
X		±0.40	
X.x		±0.30	
X.xx		±0.20	
X*		±5°	
X.x°		±3°	

Title: FPC 0.50mm Pitch 90° H2.00mm SMT With Lock Connector			
Molde Code: GT-F0507SR20-XXXXX01			
DRAWN	CHECKED	APPROVED	DATE
Jiang	Hu	Chen	2021.06.28



REV: A0 SHEET: 2/2