

SS-23D15-GXXX

直柄
G-Switch P/N

Switch Height (mm)

G020=2.0	G030=3.0
G040=4.0	G050=5.0
G055=5.5	G060=6.0
G065=6.5	G070=7.0
G075=7.5	G080=8.0
G085=8.5	G090=9.0
G095=9.5	G100=10.0

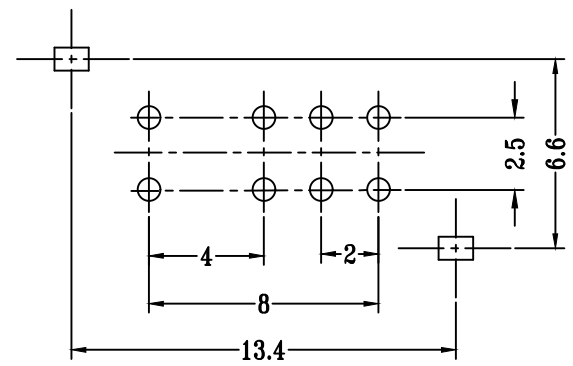
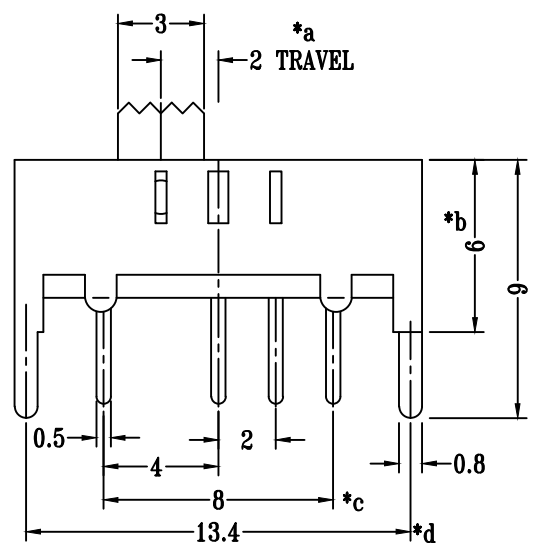

**P.C.B LAYOUT
BOTTOM VIEW**

G-Switch Specification:
 Electrical Specifications: 1.0A/DC24V
 Contact resistance (CR): ≤50mΩ
 Insulation Resistance(IR): ≥100MΩ DC250V
 Compressive strength (WV): AC250V 1minute
 Operating temperature: -25°C~+70°C
 Storage humidity: <85%RH
 Electrical life: 10,000Cycles.

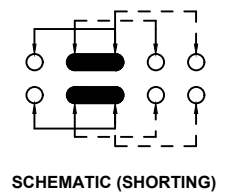

G-Switch Electronic (HongKong) CO.,Ltd.

Unless otherwise specified, Tolerance:
 X. ±0.30
 X.x ±0.20
 X.xx ±0.15
 X.xxx ±0.10
 Angles ±3°

DESIGN FengFengChen	DATE 2019.05.29	Molde code:		
CHECKED	DATE	SS-23D15-GXXX		
APPROVED	DATE			
http://www.dg-switch.com		REV.: X1	SCALE: 4:1	UNIT: mm
TEL:0769-82388879		SIZE: A4	SHEET: 1/1	